

OPLATE ŠITUM

DokMax oplate

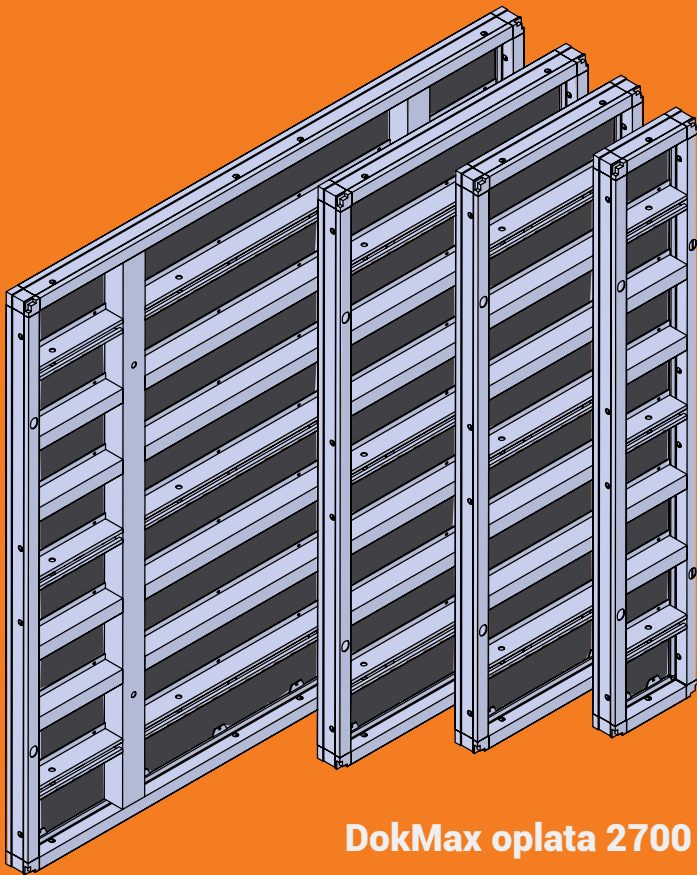

DokMax oplate 2700

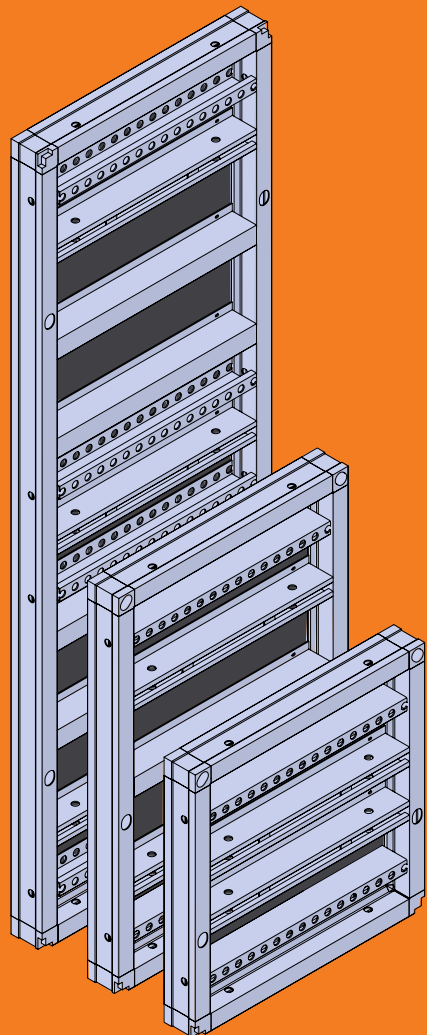

DokMax oplate uni



www.oplate-situm.com

DokMax oplate

Sustav oplata **DokMax** je kompletan sustav koji uključuje i pripadajuće dijelove te omogućuje savršenu kvalitetu izrade betonskih konstrukcija.

DokMax oplata 2700

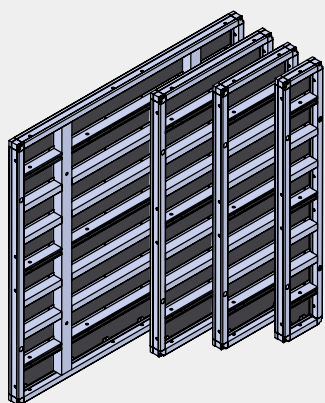

šifra	dimenzija (m)	težina (kg)
G 491	2,70x2,70	416,00
G 051	2,40x2,70	370,00
G 050	1,35x2,70	210,00
G 049	0,90x2,70	126,00
G 048	0,60x2,70	91,00
G 047	0,55x2,70	87,00
G 046	0,50x2,70	83,00
G 045	0,45x2,70	77,00
G 044	0,30x2,70	61,00

DokMax oplata uni

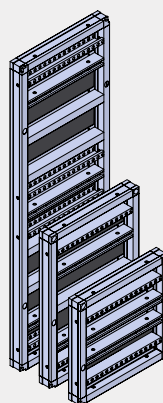

šifra	dimenzija (m)	težina (kg)
G 076	1,20x3,30	276,00
G 075	1,20x2,70	225,00
G 074	1,20x1,35	116,00
G 073	1,20x0,90	91,00
G 072	0,90x3,30	182,00
G 071	0,90x3,00	165,00
G 070	0,90x2,70	148,00
G 069	0,90x1,35	79,00
G 068	0,90x0,90	63,00

DokMax oplata 3000

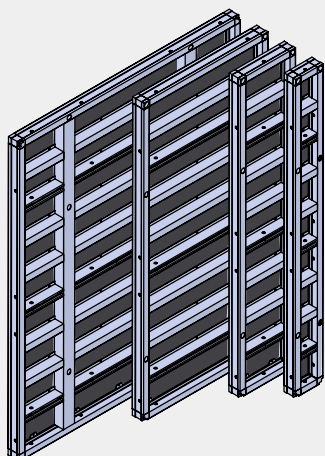

šifra	dimenzija (m)	težina (kg)
G 426	2,70x3,00	465,00
G 059	2,40x3,00	427,00
G 058	1,35x3,00	234,00
G 057	0,90x3,00	140,00
G 056	0,60x3,00	102,00
G 055	0,55x3,00	97,00
G 054	0,50x3,00	92,00
G 053	0,45x3,00	87,00
G 052	0,30x3,00	70,00

DokMax oplata 3300

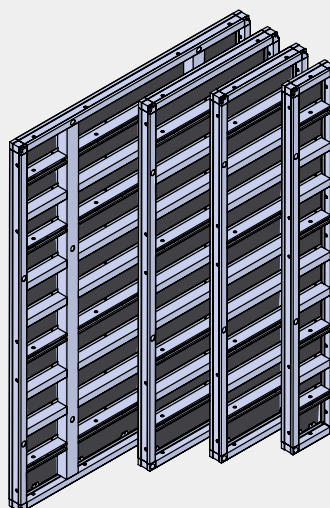

šifra	dimenzija (m)	težina (kg)
G 492	2,70x3,30	514,00
G 067	2,40x3,30	484,00
G 066	1,35x3,30	259,00
G 065	0,90x3,30	154,00
G 064	0,60x3,30	113,00
G 063	0,55x3,30	107,00
G 062	0,50x3,30	104,00
G 061	0,45x3,30	97,00
G 060	0,30x3,30	78,00

DokMax kut

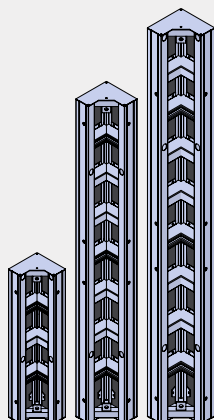

šifra	dimenzija (m)	težina (kg)
G 084	3,30	117,00
G 083	3,00	107,00
G 082	2,70	97,00
G 081	1,35	51,00

DokMax lomljivi kut

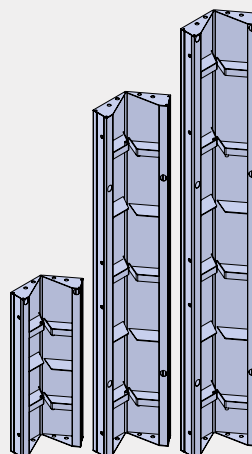

šifra	dimenzija (m)	težina (kg)
G 092	3,30	129,00
G 091	3,00	105,00
G 090	2,70	57,00
G 089	1,35	41,00

DokMax vanjski kutnik

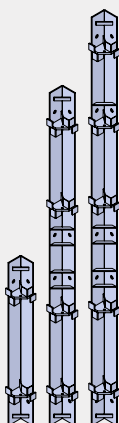

šifra	dimenzija (m)	težina (kg)
G 088	3,30	58,00
G 087	3,00	52,00
G 086	2,70	47,00
G 085	1,35	23,00

DokMax vanjski lomljivi kut

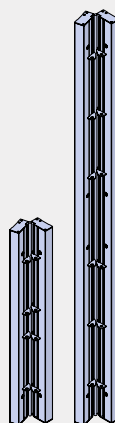

šifra	dimenzija (m)	težina (kg)
G 404	3,30	64,50
G 402	2,70	52,00
G 405	1,35	27,00
G 406	0,90	17,00

DokMax kut za lift

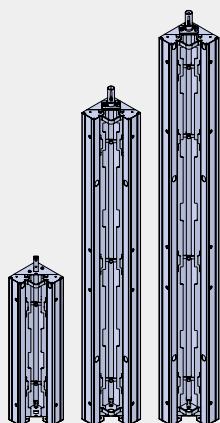

šifra	dimenzija (m)	težina (kg)
G 099	3,30	210,00
V134	3,00	190,00
G 098	2,70	170,00
G 097	1,35	90,00

DokMax stezna spojka

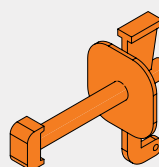

šifra	težina (kg)
V 034	1,50

DokMax šina 0,90 i 1,50

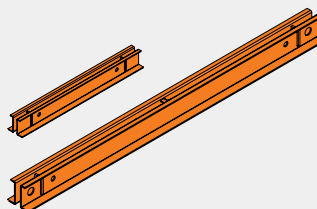

šifra	dimenzija (m)	težina (kg)
G 02	0,90	10,00
G 03	1,50	16,00

DokMax brza spojnica

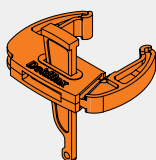

šifra	težina (kg)
V 031	3,30

DokMax UNI spojnica

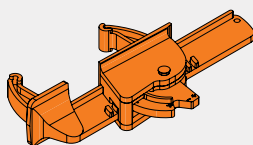

šifra	težina (kg)
V 032	5,20

DokMax T-vijak

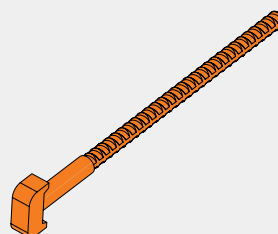

šifra	težina (kg)
V 031	0,69

DokMax UNI spojnica sa šarafom

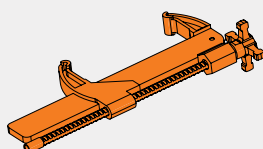

šifra	težina (kg)
V 036	5,30

DokMax zavojnica Super navojnica

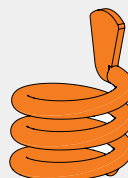

šifra	težina (kg)
V 501	0,10

DokMax hvataljka za premještanje

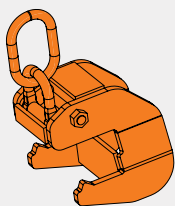

šifra	težina (kg)
V 033	10,55

DokMax super vijak



šifra	težina (kg)
V 510	0,30

DokMax čeono sidro

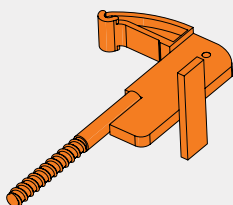

šifra	težina (kg)
V 240	1,50

DokMax UNI čep

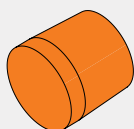

šifra	težina (kg)
V 054	0,02

DokMax čep za oplatu

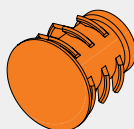

šifra	težina (kg)
V 054	0,03

DokMax superploča

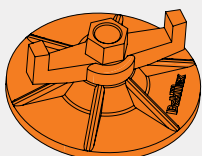

šifra	težina (kg)
V 029	0,91

DokMax transportni konus

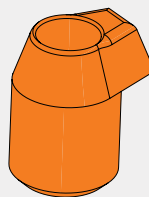

šifra	težina (kg)
V 525	0,04

DokMax konzola 090

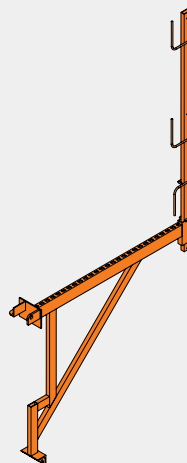

šifra	težina (kg)
G 431	12,00

DokMax kosnik 340

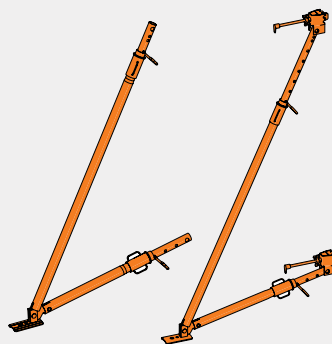

šifra	težina (kg)
V 028	31,00

DokMax kosnik 540

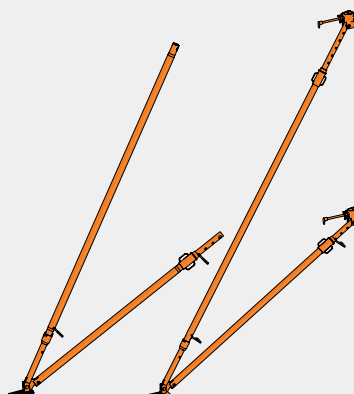

šifra	težina (kg)
V 114	48,00